

Dixi

Medium Low Pressure Gas Regulator

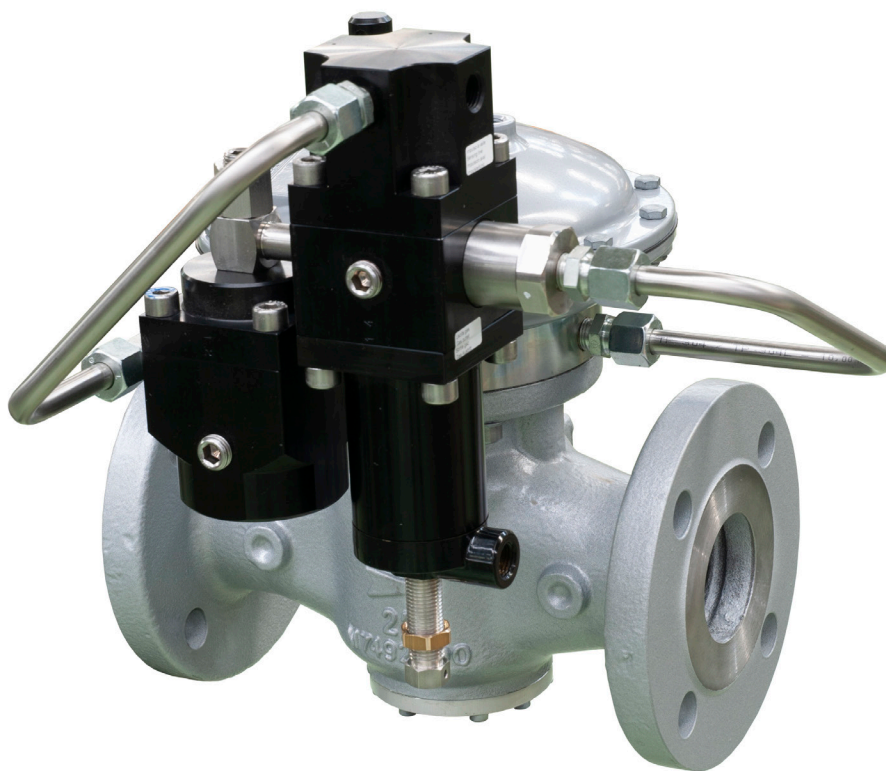

TECHNICAL BROCHURE

Pietro Fiorentini S.p.A.

Via E.Fermi, 8/10 | 36057 Arcugnano, Italy | +39 0444 968 511
sales@fiorentini.com

The data are not binding. We reserve the right
to make changes without prior notice.

dixi_technicalbrochure_ENG_revC

www.fiorentini.com

Who we are

We are a global organization specialized in designing and manufacturing technologically advanced solutions for natural gas treatment, transmission and distribution systems.

We are the ideal partner for operators in the Oil & Gas sector, with a business offer that goes across the whole natural gas chain.

We are in constant evolution to meet our customers' highest expectations in terms of quality and reliability.

Our aim is to be a step ahead of the competition, with customized technologies and an after-sale service program undertaken with the highest grade of professionalism.



Pietro Fiorentini advantages



Localised technical support



Experience since 1940



We operate in over 100 countries

Area of Application

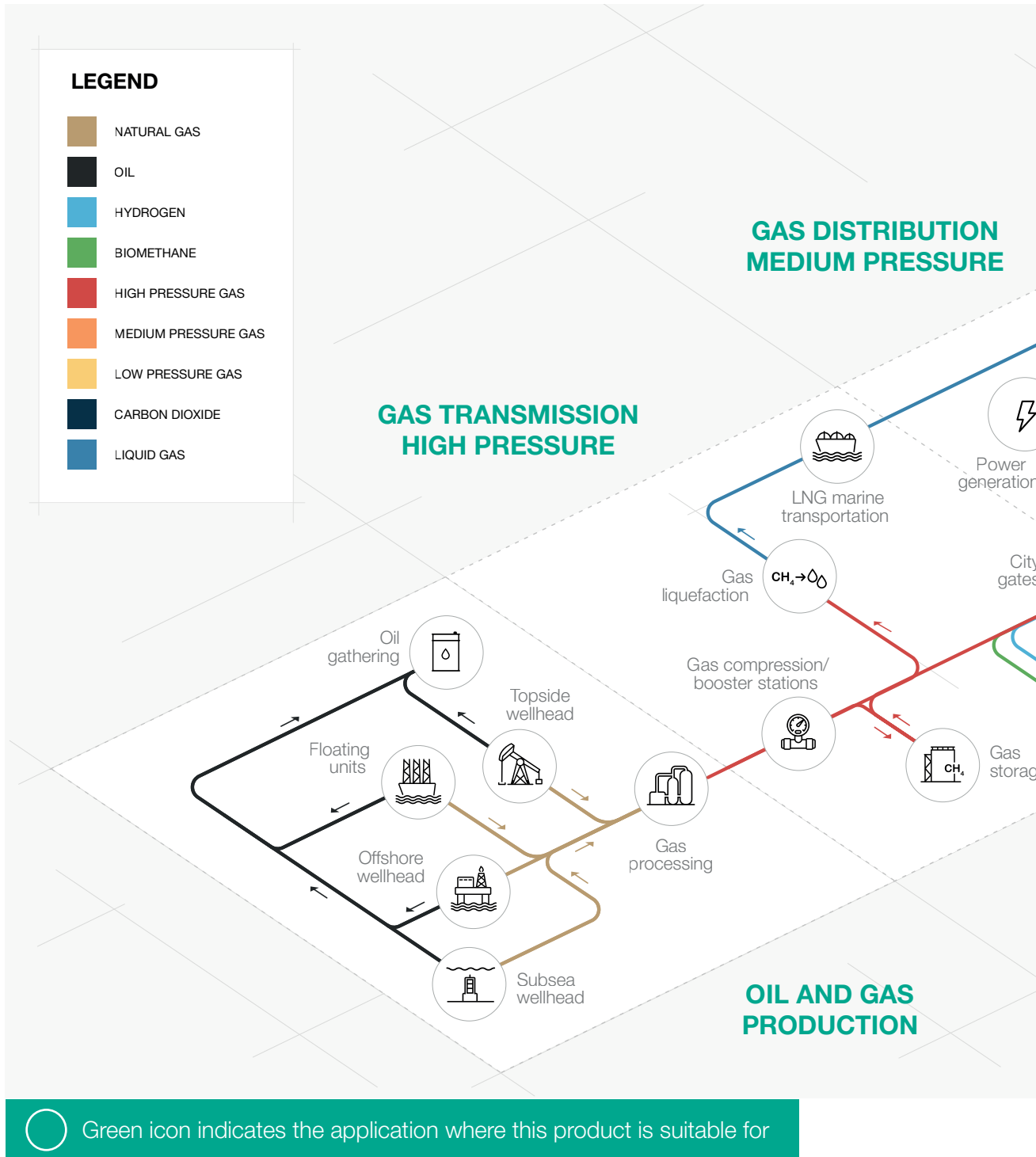

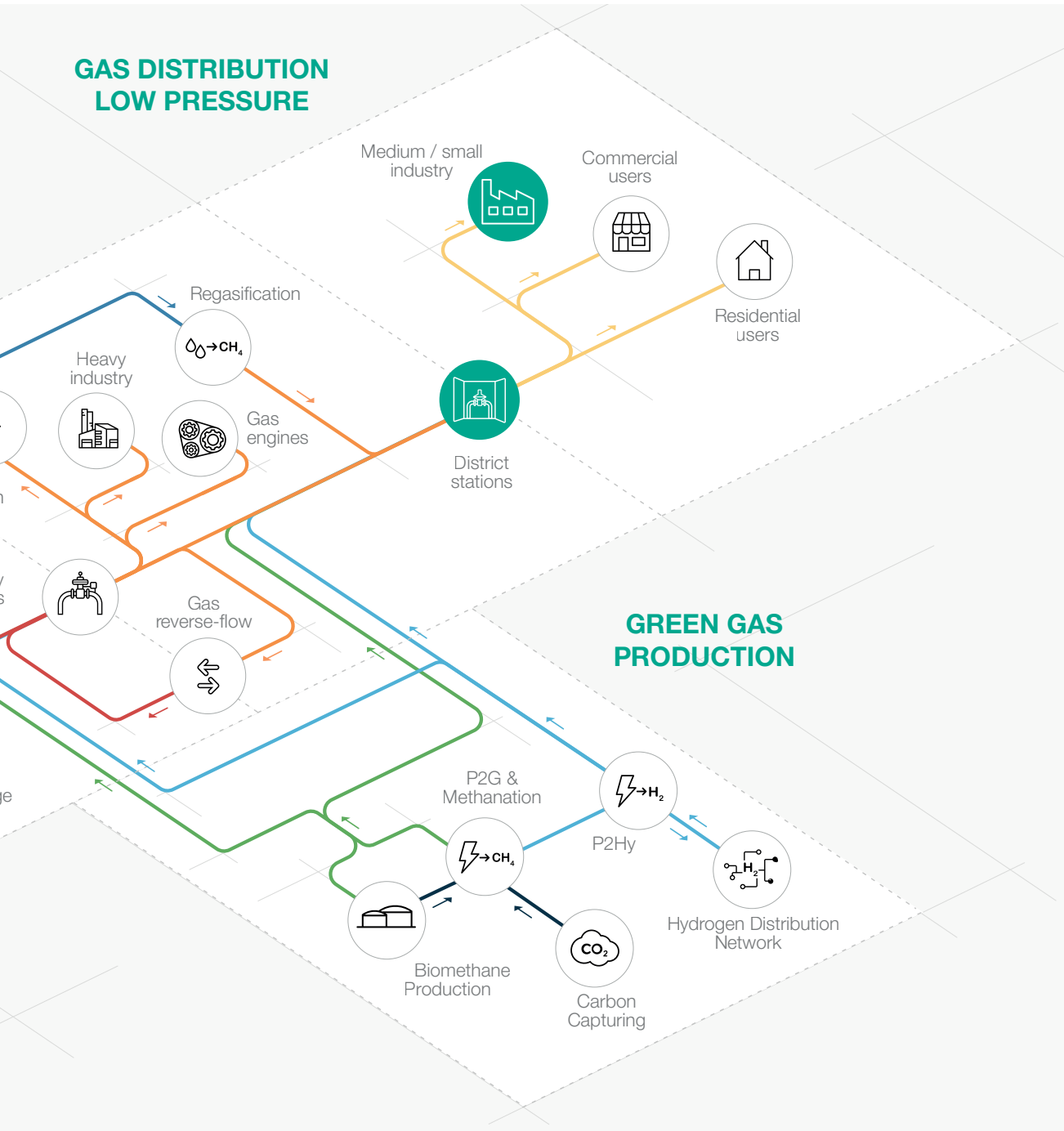

Figure 1 Area of Application Map



Introduction

Dixi is one of the **pilot-operating gas pressure regulators** designed and manufactured by Pietro Fiorentini.

This device is suitable for use with previously filtered non-corrosive gases, and it is mainly used for medium and low pressure natural gas distribution networks.

According to the European Standard EN 334, it is classified as Fail Close (pilot series 200/A) or Fail Open (pilot series 210/A) according to the installed pilot.

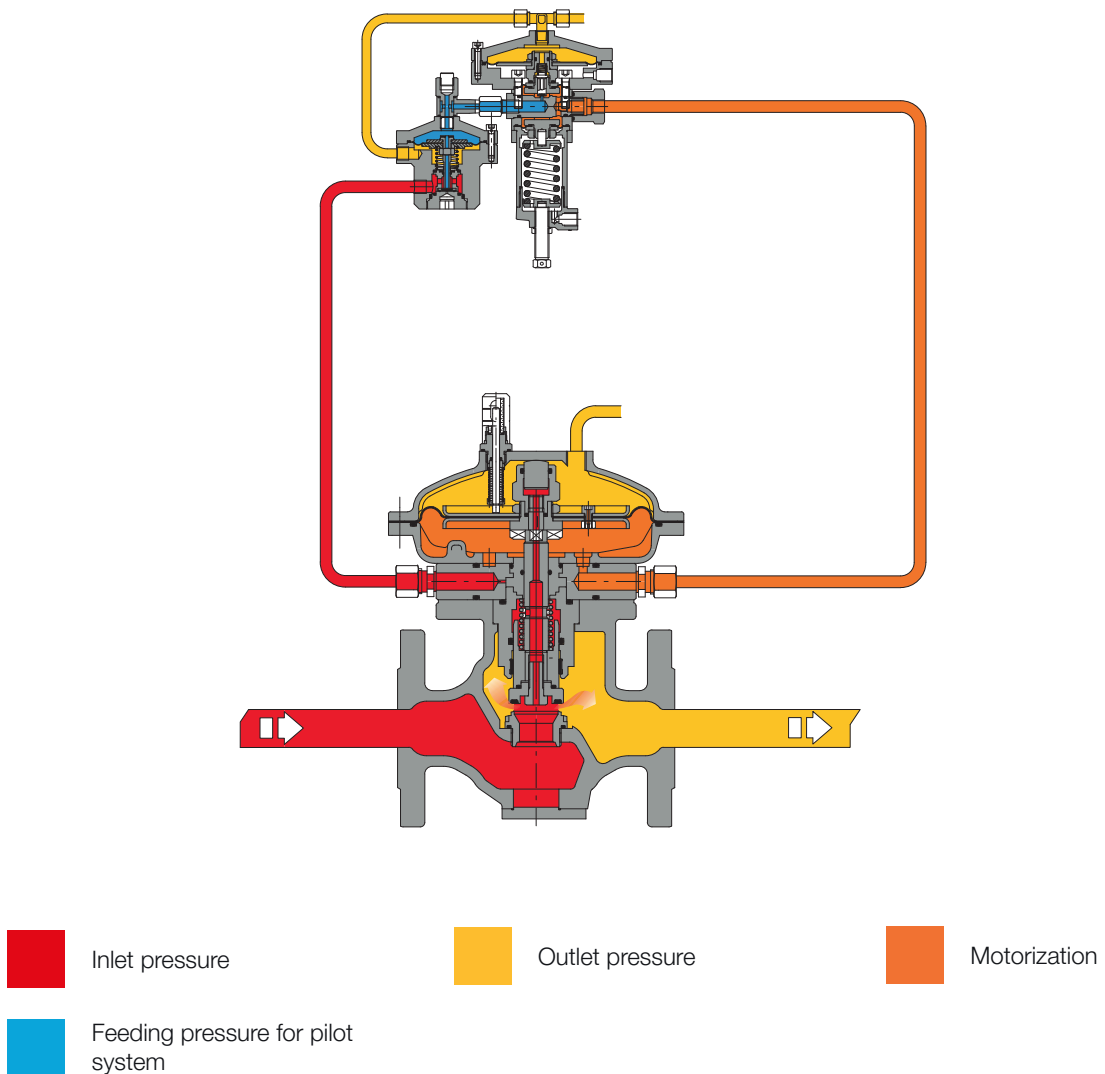

Figure 2 Dixi

Features and Calibration ranges

The **Dixi** is a **pilot-operated** device for medium pressure and low pressure with a unique **dynamic balancing system** which ensures an **outstanding turn down ratio** combined with an extremely **accurate outlet pressure control**.

A balanced pressure regulator it is a pressure regulator where delivery pressure accuracy it is not affected by the fluctuation of the inlet pressure and flow during its operation. Therefore, a balance pressure regulator can have a single orifice for all pressure and flow operating conditions.

This regulator is suitable for use with previously filtered, non corrosive gases and distribution networks as well as high load industrial applications.

It is a **truly top entry design** which allows an **easy maintenance** of parts directly in the field **without removing the body from the pipework**.

Set point adjustment of the regulator is operated via a pilot unit used to load and unload the bleeding pressure from the top chamber.

The modular design of Dixi pressure regulators allows LA slam shut valve.

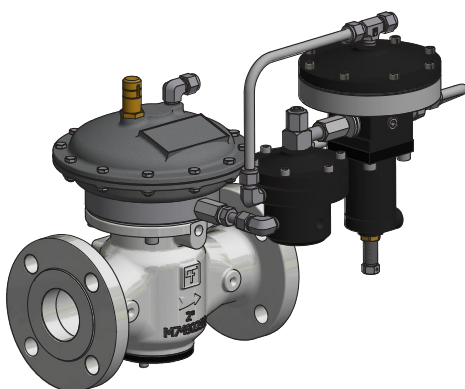

Figure 3 Dixi

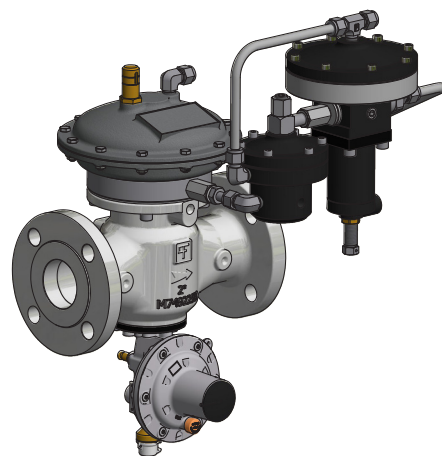











Figure 4 Dixi with LA slam shut valve



Dixi competitive advantages

-  Compact and simple design
-  High accuracy
-  High turn-down ratio
-  Fail Close plug and seat regulator
-  Built-in pilot filter
-  Top Entry
-  Easy maintenance
-  In-build accessories
-  Balanced type
-  Biomethane compatible and 10% Hydrogen blending compatible. Higher blending available on request

Features

Features	Values
Design pressure* (PS ¹ / DP ²)	up to 1.6 MPa up to 16 barg
Ambient temperature* (TS ¹)	from -20 °C to +60 °C from -4 °F to +140 °F
Inlet gas temperature*	from -20 °C to +60 °C from -4 °F to +140 °F
Inlet pressure (MAOP / p _{umax} ¹)	from 0.05 to 1.6 MPa from 0.5 to 16 barg
Range of downstream pressure (Wd ¹)	from 0.7 kPa to 0.6 MPa from 7 mbarg to 6 barg
Available accessories	LA Slam shut, opening indicator
Minimum operating differential pressure (Δp _{min} ¹)	0.01 MPa 0.1 barg
Accuracy class (AC ¹)	up to 2.5 up to 1% absolute (depending on working conditions)
Lock-up pressure class (SG ¹)	up to 10
Nominal size (DN ^{1,2})	DN 25 1"; DN 40 1" 1/2; DN 50 2";
Connections	Class 150 RF according to ASME B16.5 and PN16, 25 according to ISO 7005

⁽¹⁾ according to EN334 standard

⁽²⁾ according to ISO 23555-1 standard

^(*) NOTE: Different functional features and/or extended temperature ranges may be available on request. Stated inlet gas temperature range is the maximum for which the equipment's full performance, including accuracy is guaranteed. Product may have a different pressure or temperature ranges according to the version and/or installed accessories.

Table 1 Features

Materials and Approvals

Part	Material
Body	Cast steel ASTM A216 WCB for all sizes Ductile cast iron GS 400-18 ISO 1083
Heads	Die cast aluminium EN AC 43500
Seat	Stainless steel
Diaphragm	Rubberized canvas
O-rings	Nitrile Rubber
Compression fittings	According to DIN 2353 in zinc-plated carbon steel. Stainless steel on request

NOTE: The materials indicated above refer to the standard models. Different materials can be provided according to specific needs.

Table 2 Materials

Construction Standards and Approvals

Dixi regulator is designed according to the European standard EN 334.

The regulator reacts in closing (Fail Close) or opening (Fail Open) according to EN 334 depending on the pilot installed.

The product is certified according to European Directive 2014/68/EU (PED).

Leakage class: bubble tight, better than VIII according to ANSI/FCI 70-3.



EN 334



PED-CE*

*Not applicable for regulators with pilot series 210



Pilot ranges and types

Type	Model	Operation	Range Wh		Spring Table web link
			kPa	mbarg	
Main pilot	201/A	Manual	0.7 - 58	7 - 580	TT 475
			MPa	barg	
Main pilot	204/A	Manual	0.03 - 0.6	0.3 - 6	TT 433
Main pilot	214/A	Manual	0.03 - 0.6	0.3 - 6	TT 433

Table 3 Settings table

Pilot adjustment	
Pilot type .../A	Manual setting
Pilot type .../D	Electric remote control setting
Pilot type .../CS	Pneumatic remote control setting
Pilot type .../MP	Magnetic pilot for remote control setting / flow limitation

Table 4 Pilot adjustment table

General link to the calibration tables: [PRESS HERE](#) or use the QR code:



Accessories

For the pressure regulators:

- Cg limiter
- Limit switches
- Position transmitter
- Slam shut valve

For the pilot circuit:

- Supplementary filter CF14 or CF14/D

In-line Monitor

The in-line monitor is generally installed upstream of the active regulator.

Although the function of the monitor regulator is different, the two regulators are virtually identical from the point of view of their mechanical components.

The only difference is that monitor is set at a higher pressure than active regulator.

The Cg coefficients of the worker regulator with an in-line monitor is the same, but during worker regulator sizing it shall be considered the differential pressure drop generated by the fully open in-line monitor. As a practice, to incorporate this effect a Cg reduction of 20% of the worker regulator can be applied.

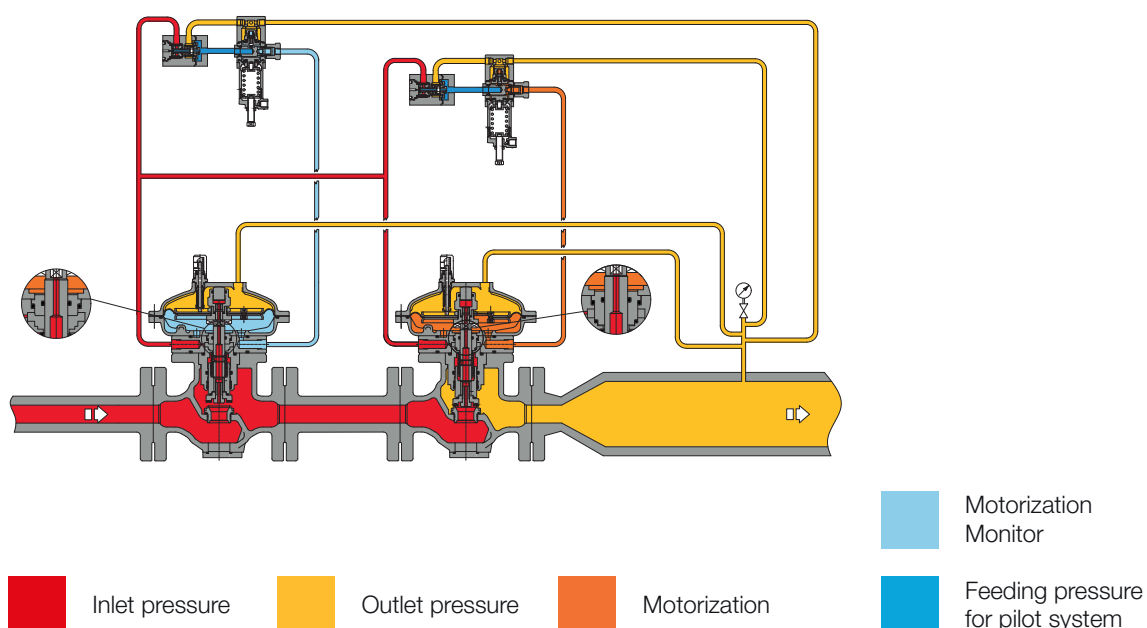

Figure 5 Dixi inline monitor



Slam Shut LA









The dixi pressure regulator offers the possibility of installing an **incorporated slam shut valve LA** and this can be done either during the manufacturing process or be retrofitted in the field.

LA is available for all sizes.

Retrofitting can be done without modifying the pressure regulator assembly.

With the built-in slam shut, the Cg valve coefficients is 5% lower than the corresponding version without.

The main characteristics of this device are:

-  Over Pressure Shut-Off
-  Under Pressure Shut-Off
-  Internal by-pass
-  Push button for tripping test
-  Compact dimensions
-  Easy maintenance
-  Remote tripping option
-  Limit switch option

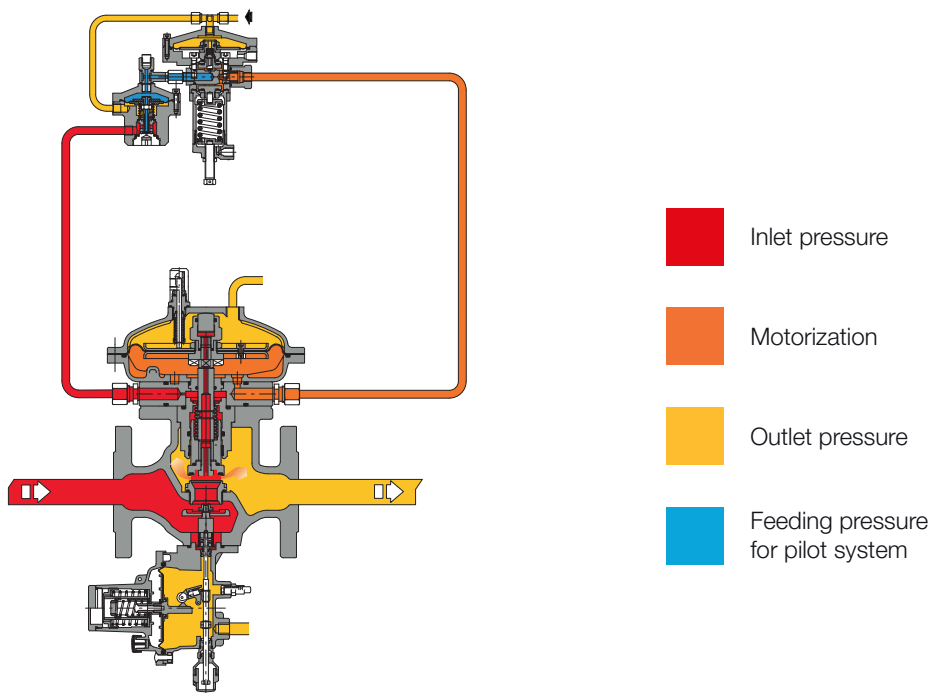

Figure 6 Dixi with LA

Pressure switch types and ranges					
SSV Type	Model	Operation	Range Wh		Spring Table web link
			KPa	mbarg	
LA	BP	OPSO	3 - 18	30 - 180	IT 00214
		UPSO	0.6 - 6	6 - 60	
LA	MP	OPSO	14 - 45	140 - 450	IT 00214
		UPSO	1 - 24	10 - 240	
LA	TR	OPSO	25 - 550	250 - 5500	IT 00214
		UPSO	10 - 350	100 - 3500	

Table 5 Settings table

Pilot series 210 fail to open (optional)

The pilot series 210/A is a mechanical device which enables the working principle and the setpoint modifications of pilot operated gas pressure regulators. The pilot is optimized to enhance the accuracy and minimize the lock-up. This model specifically allow to have a **fail-to-open regulator in case of pilot's failure**. The pilot series 210/A is not certified for PED-CE applications.

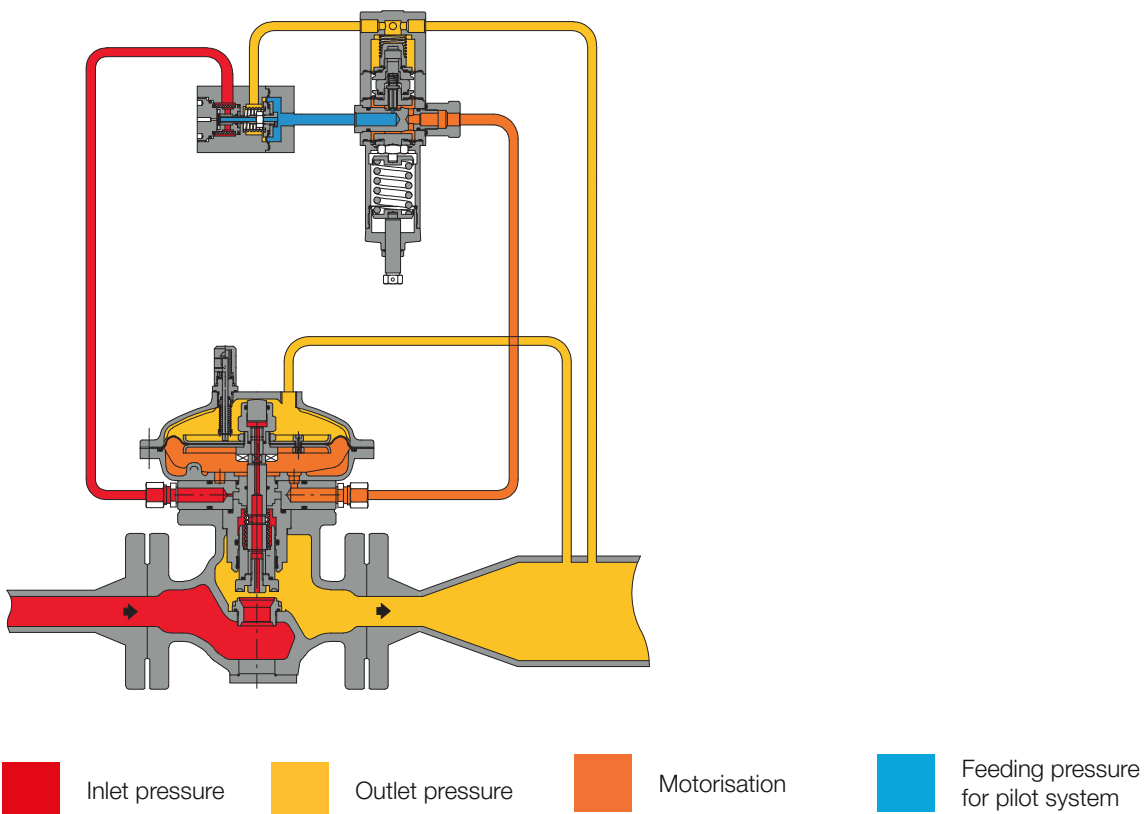

Figure 7 Dixi with fail to open pilot series 210



Weights and Dimensions

Dixi

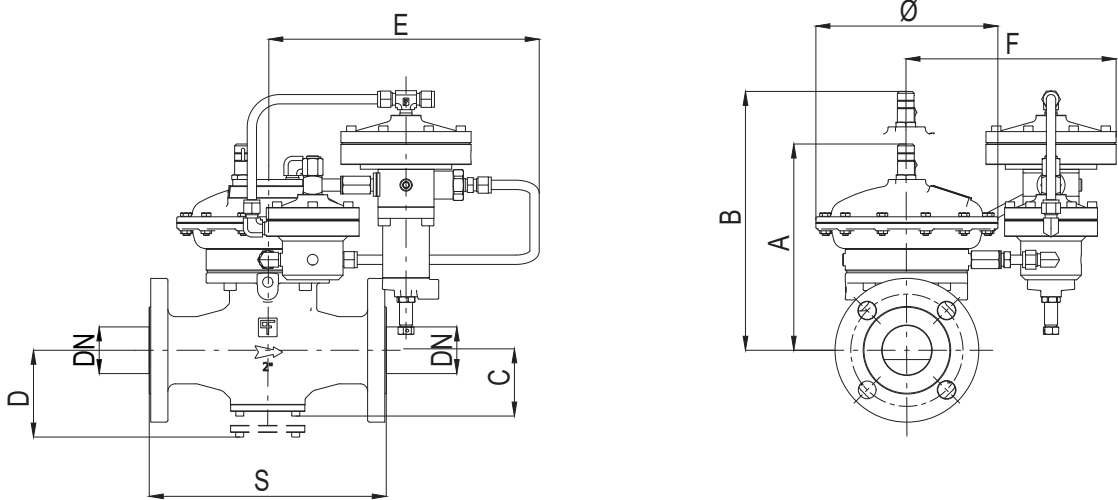

Figure 8 Dixi dimensions

Weights and Dimensions (for other connections please contact your closest Pietro Fiorentini representative)				
	[mm] inches	[mm] inches	[mm] inches	[mm] inches
Size (DN)	25 1"	40 1" 1/2	50 2"	50 2"
Type	flanged	flanged	threaded	flanged
S - Ansi 150/PN 16	183 7.2"	223 8.78"	220 8.66"	254 10"
Ø	200 7.87"	200 7.87"	200 7.87"	200 7.87"
A	230 9.06"	240 9.45"	240 9.45"	240 9.45"
B	260 10.24"	270 10.63"	270 10.63"	270 10.63"
C	80 3.15"	90 3.54"	90 3.54"	90 3.54"
D	100 3.94"	100 3.94"	100 3.94"	100 3.94"
E	290 11.42"	290 11.42"	290 11.42"	290 11.42"
F	210 8.27"	210 8.27"	210 8.27"	210 8.27"
Tubing Connections	Øe 10 x Øi 8 (on request imperial sizing)			
Weight	Kg lbs	Kg lbs	Kg lbs	Kg lbs
ANSI150/PN 16	12 26	15 33	16 35	21 46

Table 6 Weights and dimensions

Dixi + LA

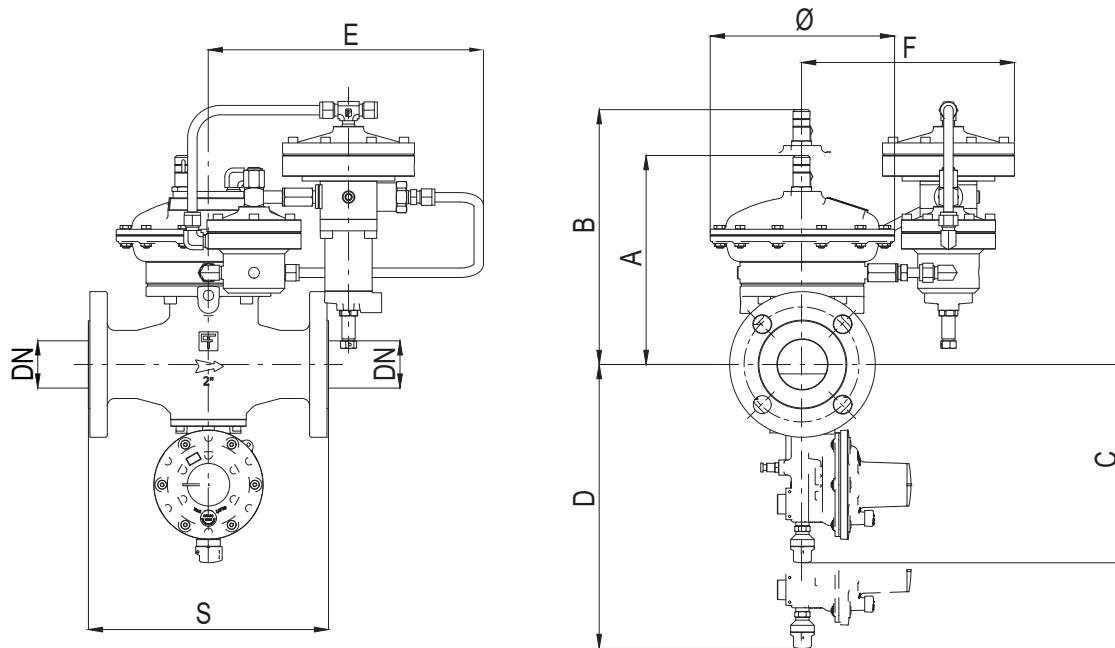

Figure 9 Dixi + LA dimensions

Weights and Dimensions (for other connections please contact your closest Pietro Fiorentini representative)				
	[mm] inches	[mm] inches	[mm] inches	[mm] inches
Size (DN)	25 1"	40 1 1/2"	50 2"	50 2"
Type	flanged	flanged	threaded	flanged
S - Ansi 150/PN 16	183 7.2"	223 8.78"	220 8.66"	254 10"
Ø	200 7.87"	200 7.87"	200 7.87"	200 7.87"
A	230 9.06"	240 9.45"	240 9.45"	240 9.45"
B	260 10.24"	270 10.63"	270 10.63"	270 10.63"
C	200 7.87"	200 7.87"	200 7.87"	200 7.87"
D	220 8.66"	220 8.66"	220 8.66"	220 8.66"
E	290 11.42"	290 11.42"	290 11.42"	290 11.42"
F	210 8.27"	210 8.27"	210 8.27"	210 8.27"
Tubing Connections	Øe 10 x Øi 8 (on request imperial sizing)			
Weight	Kg lbs	Kg lbs	Kg lbs	Kg lbs
ANSI150/PN 16	13 29	16 35	17 37	22 49

Table 7 Weights and dimensions



Sizing and Cg

In general, the choice of a regulator is made based on the calculation of the flow rate determined by the use of formulae using the flow rate coefficients (Cg) and the form factor (K1) as indicated by the EN 334 standard. Sizing available through Pietro Fiorentini's online sizing programme.

Flow rate coefficient			
Nominal size	25	40	50
Inches	1"	1" 1/2	2"
Cg	540	983	1014
K1	104	96	96

Table 8 Flow rate coefficient

For sizing [PRESS HERE](#) or use the QR code:



Note: In case you do not have the proper credentials to access, feel free to contact your closest Pietro Fiorentini representative.

In general the online sizing considers multiple variables as the regulator is installed in a system, enabling a better and multiperspective approach to the sizing.

For different gases, and for natural gas with a different relative density other than 0.61 (compared to air), the correction coefficients from the following formula shall be applied:

$$F_c = \sqrt{\frac{175.8}{S \times (273.16 + T)}}$$

S = relative density (refer to Table 9)
T = gas temperature (°C)

$$F_c = \sqrt{\frac{316.44}{S \times (459.67 + T)}}$$

S = relative density (refer to Table 9)
T = gas temperature (°F)

Correction Factor Fc		
Gas Type	Relative Density S	Correction Factor Fc
Air	1.00	0.78
Propane	1.53	0.63
Butane	2.00	0.55
Nitrogen	0.97	0.79
Oxygen	1.14	0.73
Carbon Dioxide	1.52	0.63

Note: the table shows the Fc correction factors valid for Gas, calculated at a temperature of 15°C and at the declared relative density.

Table 9 Correction Factor Fc

Flow rate conversion
$\text{Stm}^3/\text{h} \times 0.94795 = \text{Nm}^3/\text{h}$

Nm³/h Reference conditions:
 T= 0 °C; P= 1 bar(a) | T= 32 °F; P= 14.5 psi(a)
 Stm³/h Reference conditions:
 T= 15 °C; P= 1 bar(a) | T= 59 °F; P= 14.5 psi(a)

Table 10 Flow rate conversion

CAUTION:

In order to get optimal performance, to avoid premature erosion phenomena and to limit noise emissions, it is recommended to check the gas speed and its compliance with local practice and regulations. The gas speed at the outlet flange may be calculated by means of the following formula:

$$V = 345.92 \times \frac{Q}{\text{DN}^2} \times \frac{1 - 0.002 \times \text{Pd}}{1 + \text{Pd}}$$

V = gas speed in m/s
 Q = gas flow rate in Stm³/h
 DN = nominal size of regular in mm
 Pd = outlet pressure in barg

$$V = 0.0498 \times \frac{Q}{\text{DN}^2} \times \frac{14.504 - 0.002 \times \text{Pd}}{14.504 + \text{Pd}}$$

V = gas speed in ft/s
 Q = gas flow rate in Scfh
 DN = nominal size of regular in inches
 Pd = outlet pressure in psig



Sizing of regulators is usually made based on valve Cg value (table 8).

Flow rates at fully open position and various operating conditions are related by the following formulae where:

Q = flow rate in Stm³/h

Pu = inlet pressure in bar (abs)

Pd = outlet pressure in bar (abs).

- **A** > when the Cg value of the regulator is known, as well as Pu and Pd, the flow rate can be calculated as follows:

- **A-1** in sub critical conditions: (Pu < 2 x Pd)

$$Q = 0.526 \times C_g \times P_u \times \sin \left(K_1 \times \sqrt{\frac{P_u - P_d}{P_u}} \right)$$

- **A-2** in critical conditions: (Pu ≥ 2 x Pd)

$$Q = 0.526 \times C_g \times P_u$$

- **B** > vice versa, when the values of Pu, Pd and Q are known, the Cg value, and hence the regulator size, may be calculated using:

- **B-1** in sub-critical conditions: (Pu < 2 x Pd)

$$C_g = \frac{Q}{0.526 \times P_u \times \sin \left(K_1 \times \sqrt{\frac{P_u - P_d}{P_u}} \right)}$$

- **B-2** in critical conditions (Pu ≥ 2 x Pd)

$$C_g = \frac{Q}{0.526 \times P_u}$$

NOTE: The sin value is understood to be DEG.



**Pietro
Fiorentini**



Pietro Fiorentini

TB0019ENG



The data are not binding. We reserve the right
to make changes without prior notice.

dixi_technicalbrochure_ENG_revC

www.fiorentini.com